

ZWZ230

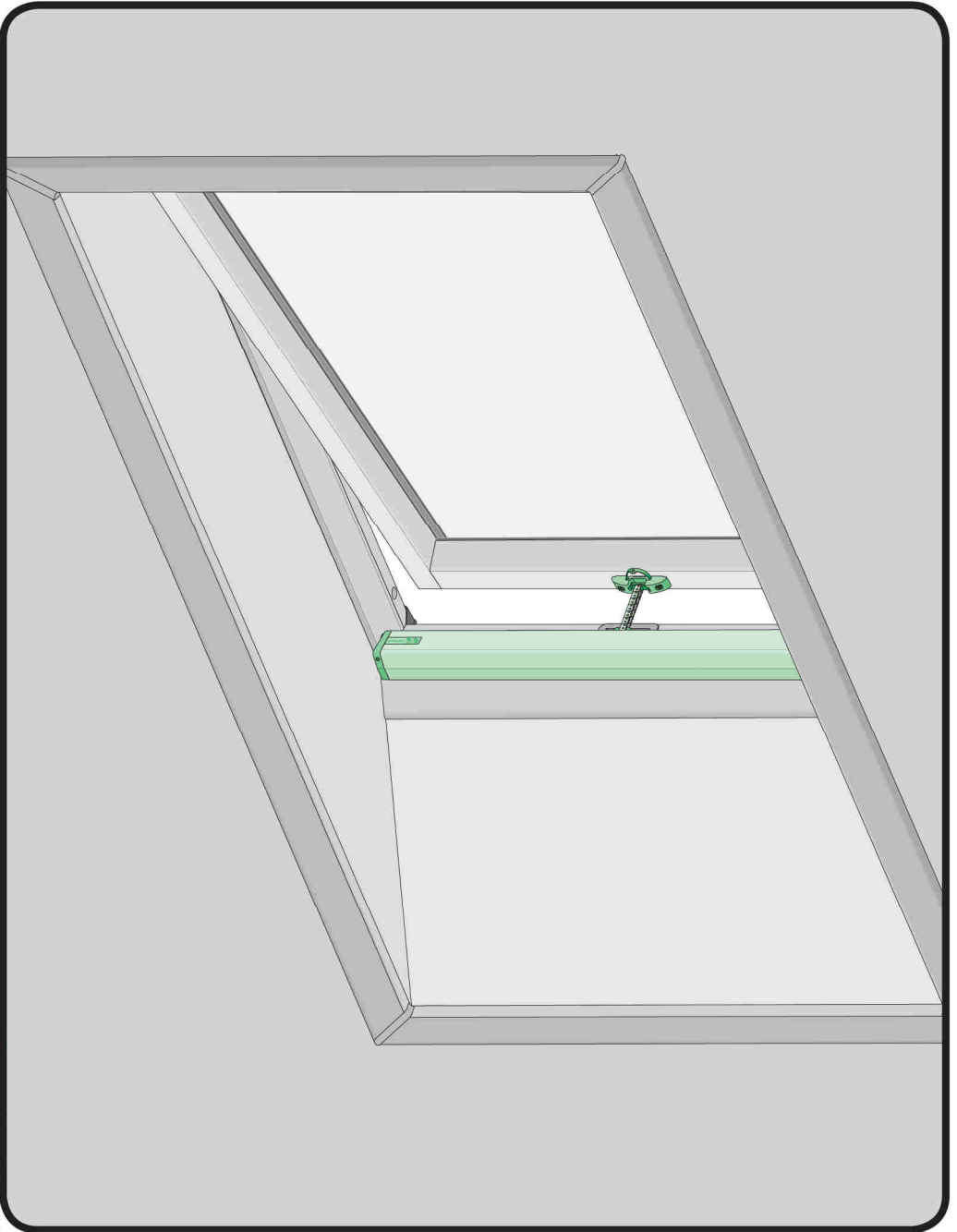

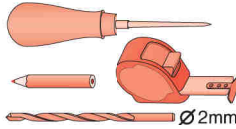

ZW230

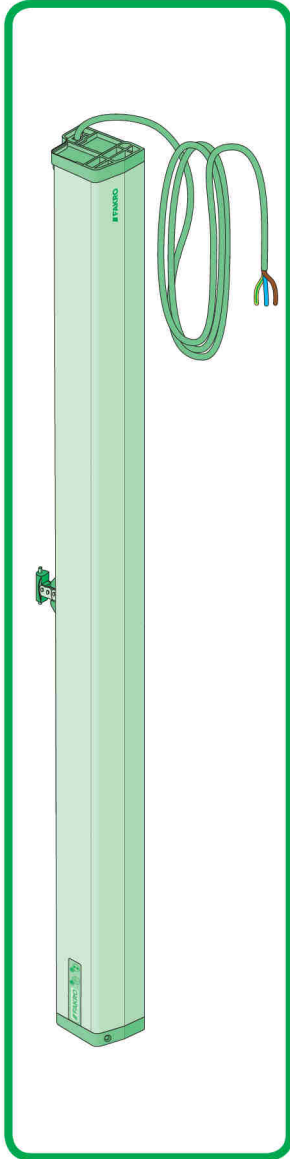

ZRH12

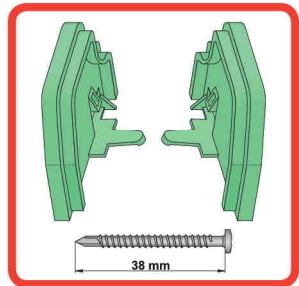
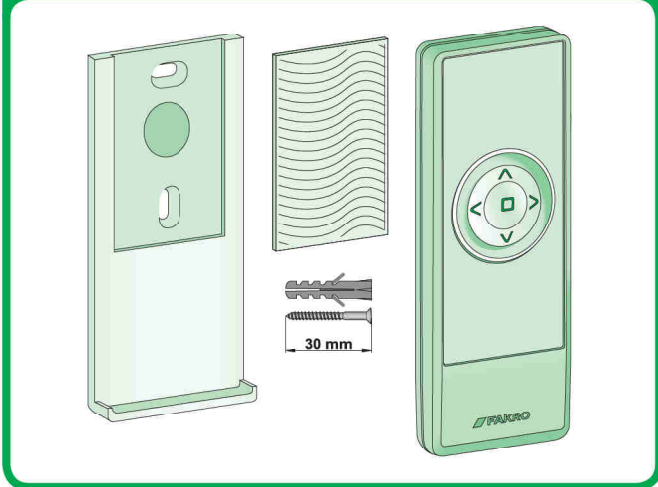

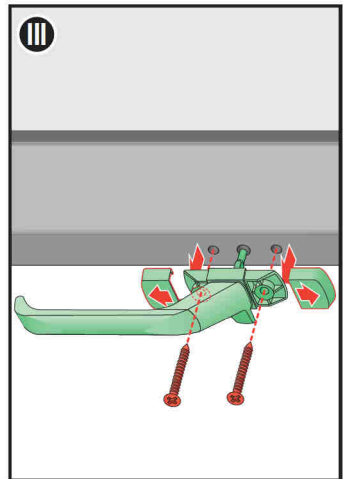
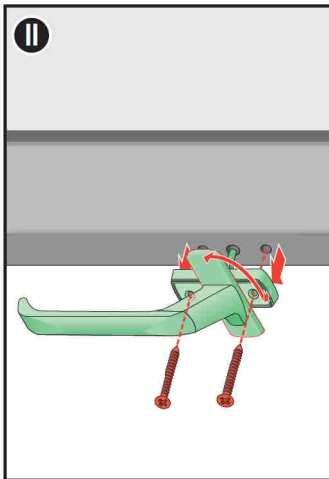
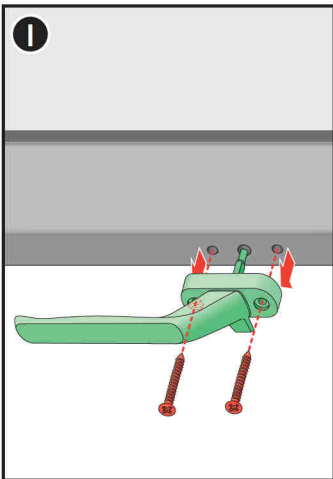
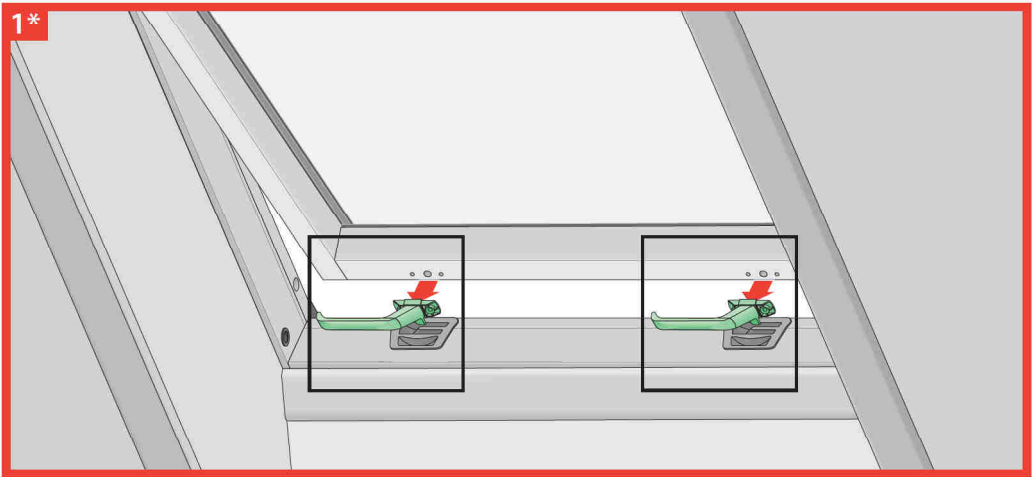
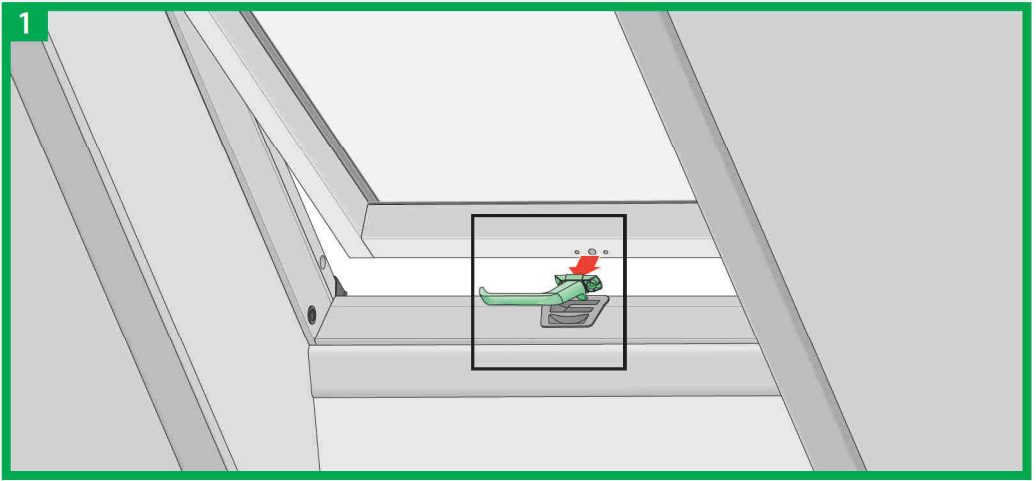

2

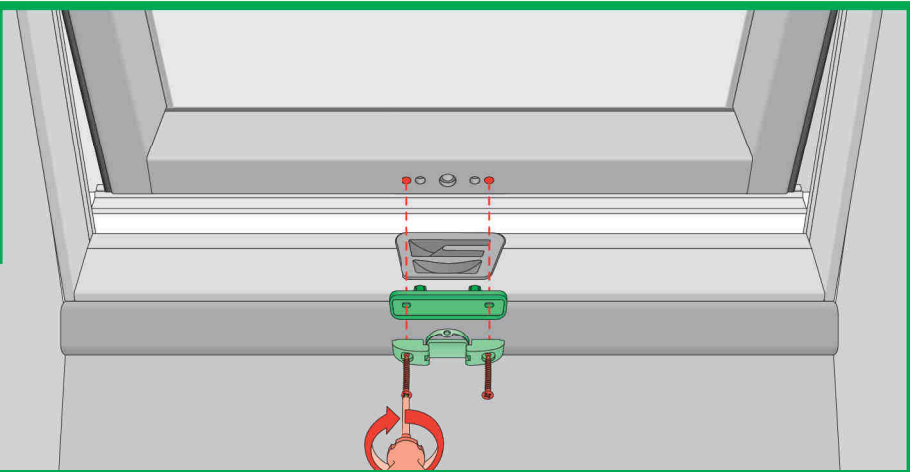
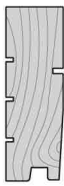

2a

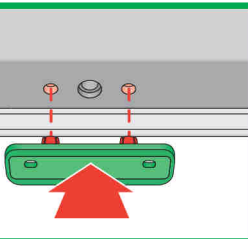

2b

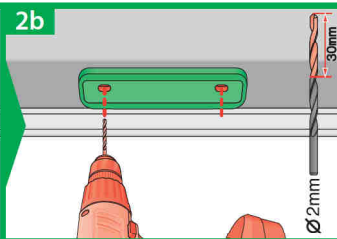

2c

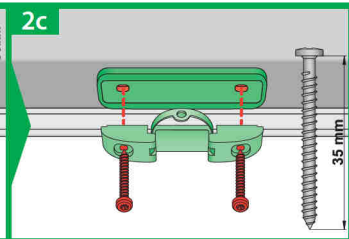

2*



PVC

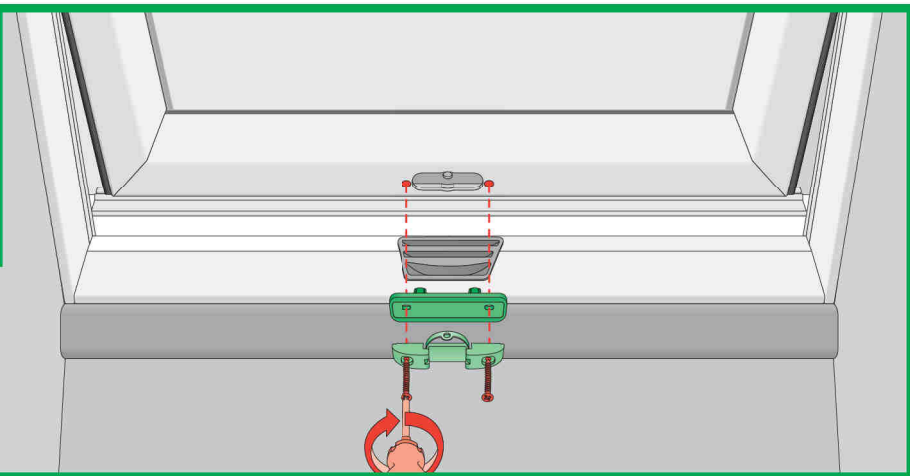

2a

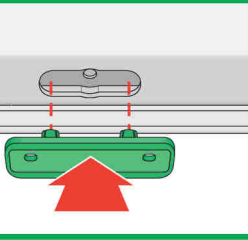

2b

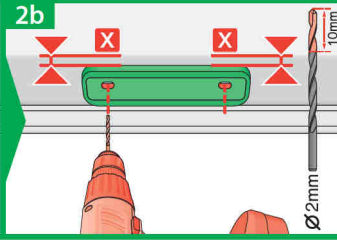

2c

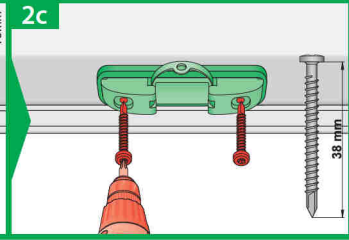

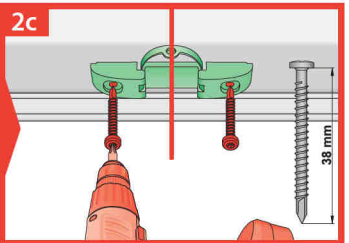
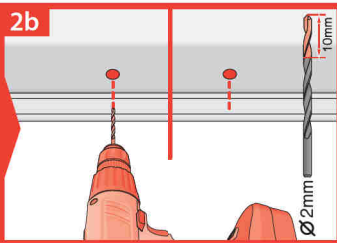
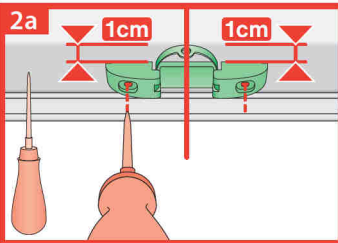
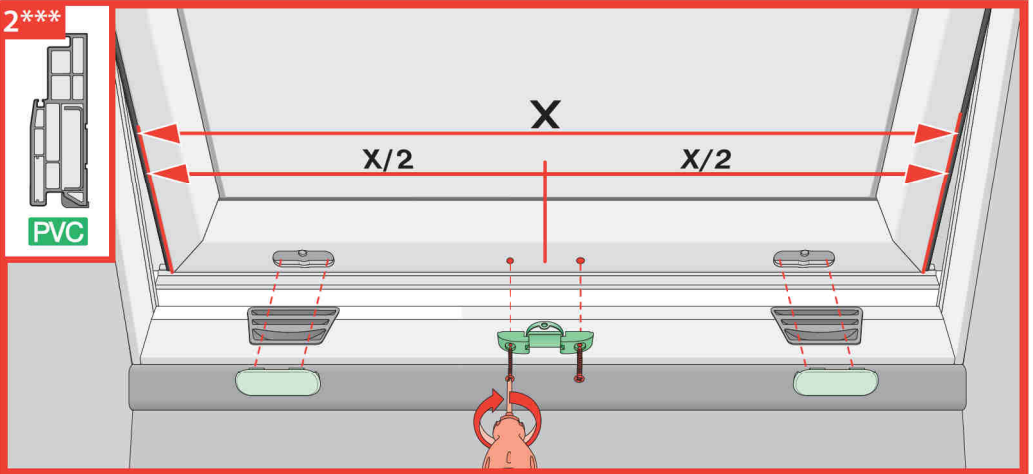
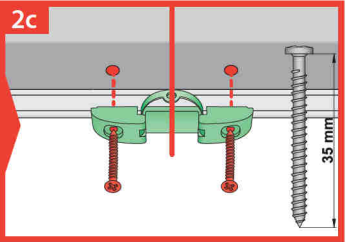
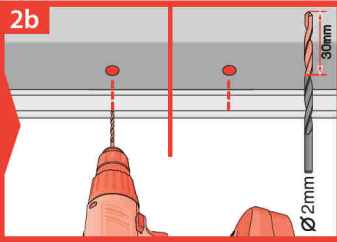
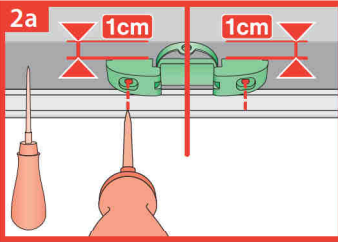
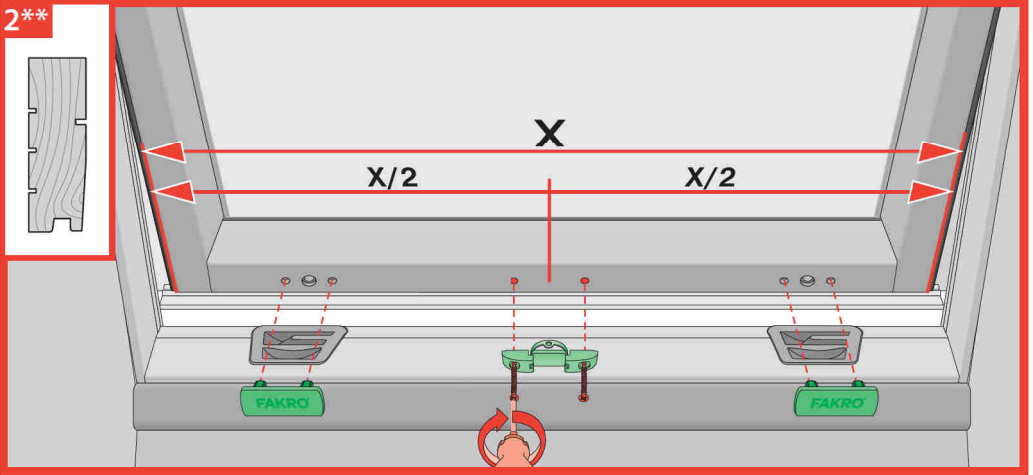

3a

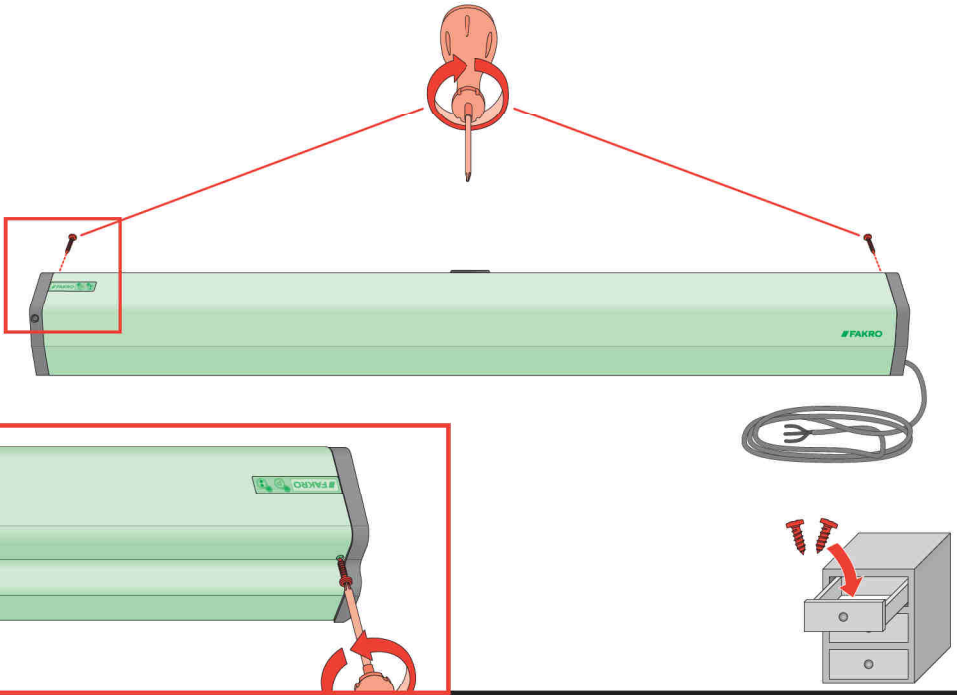

3b

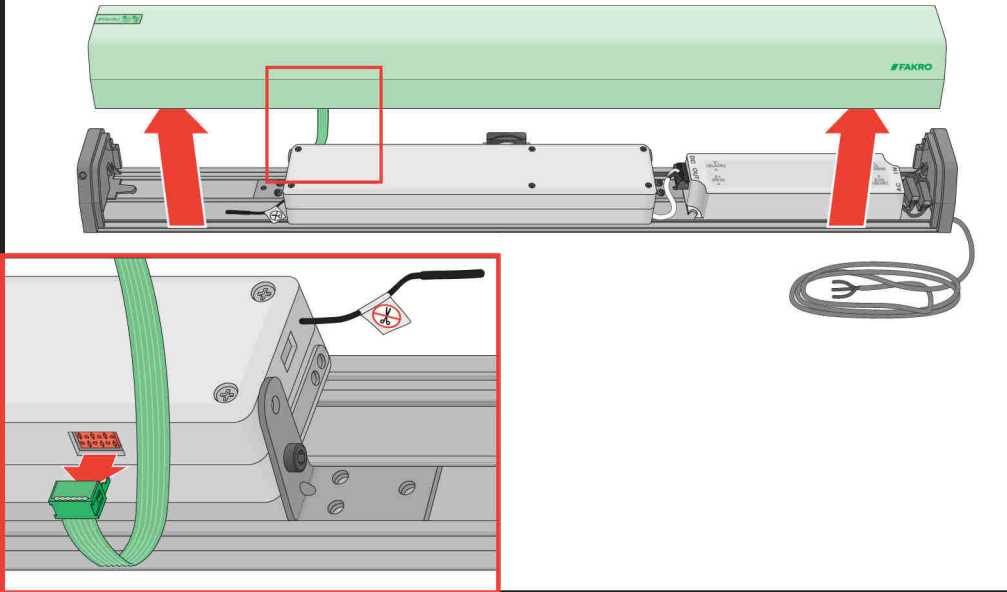

3*

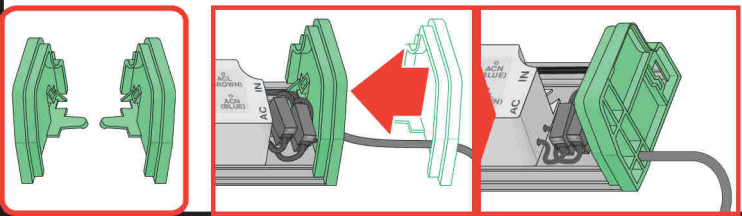
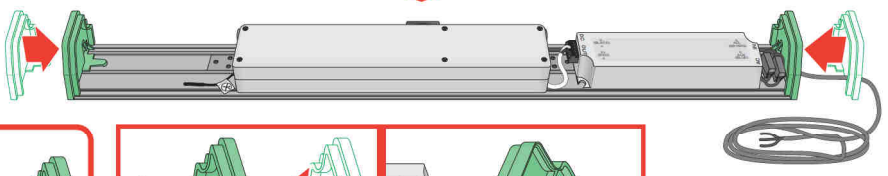
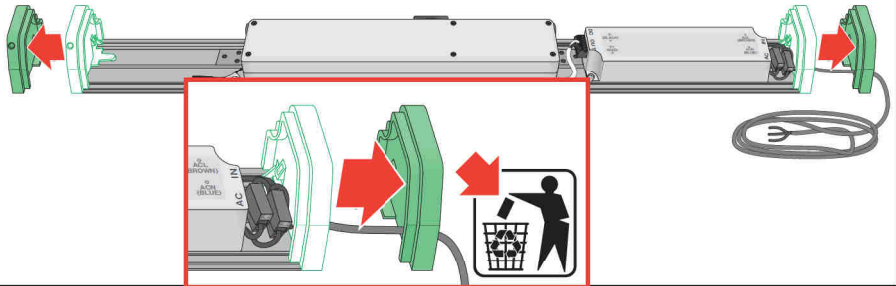
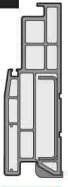

4

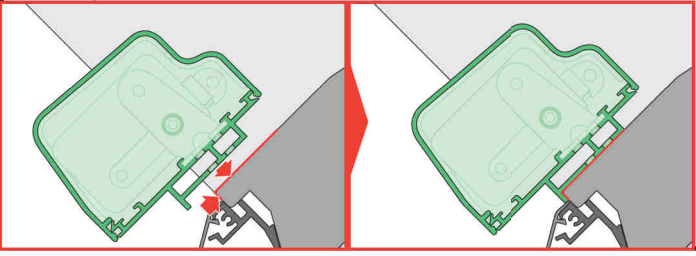
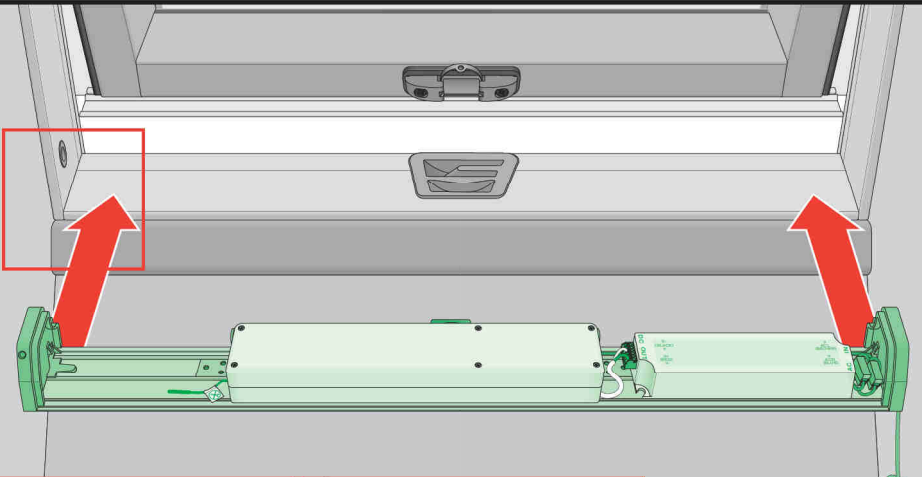

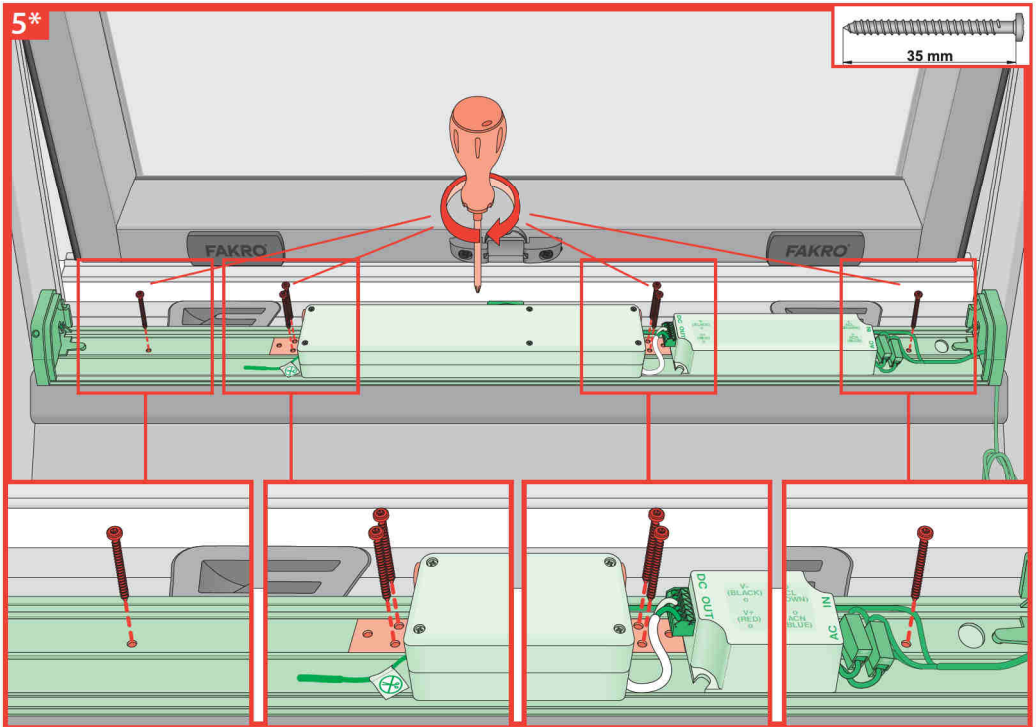
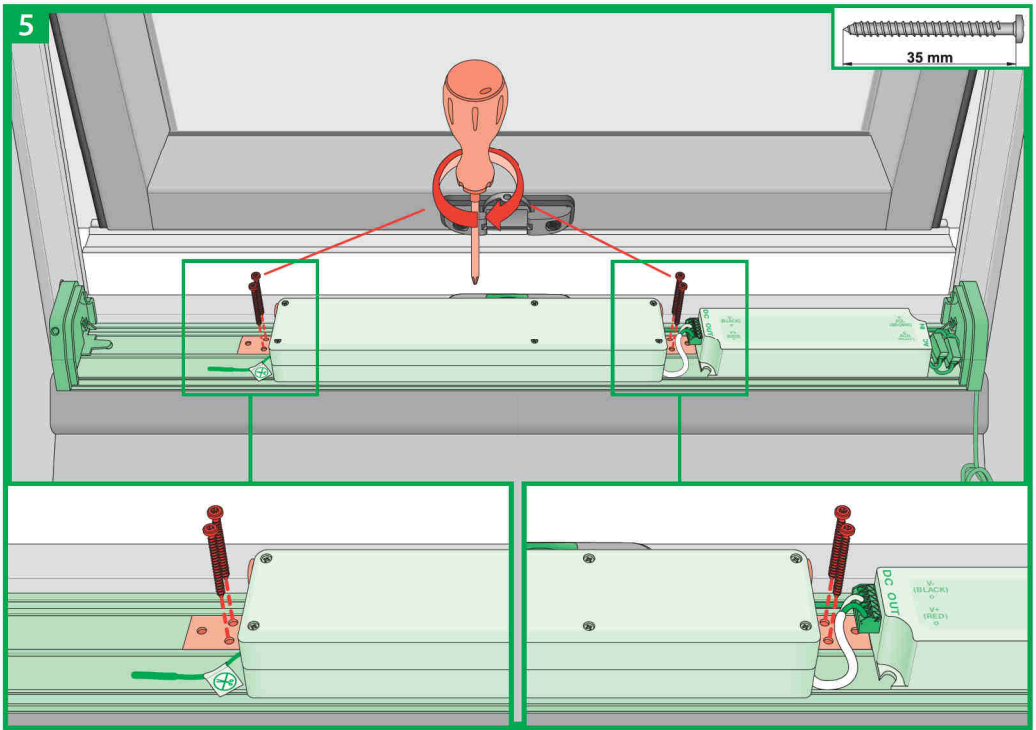

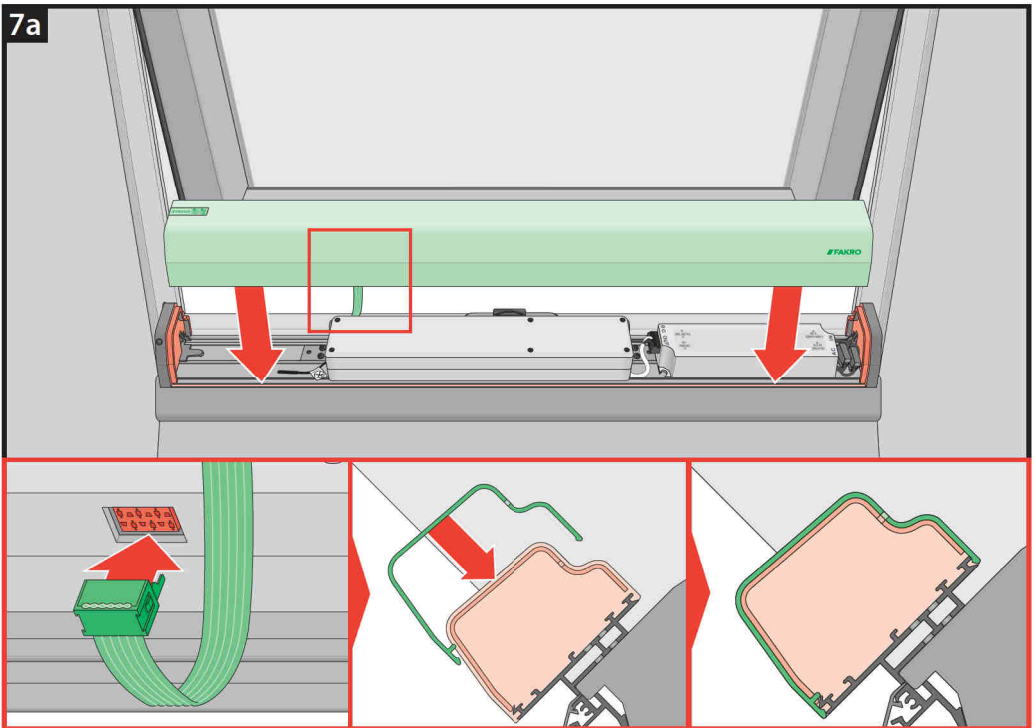
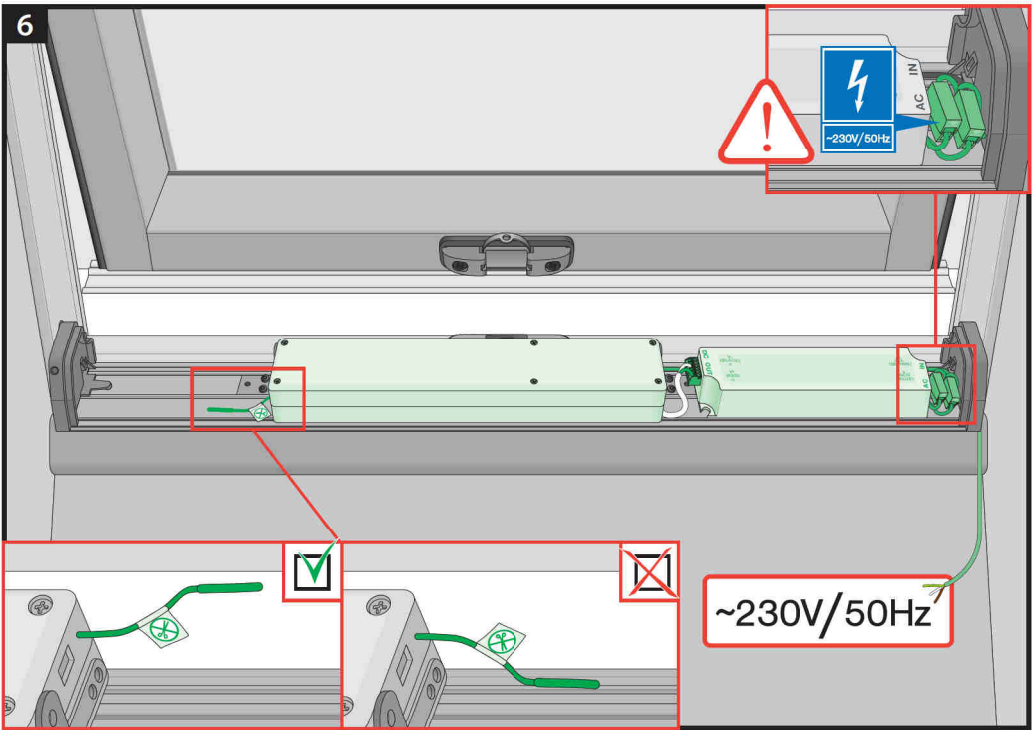

7b

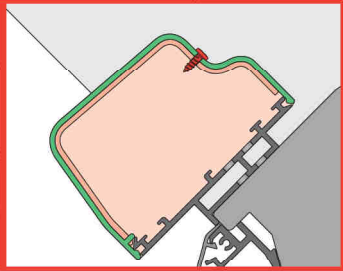
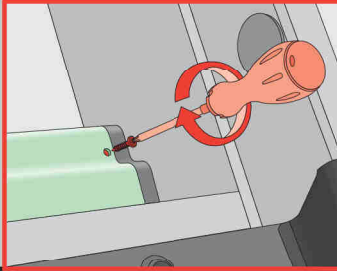
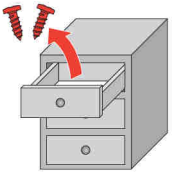
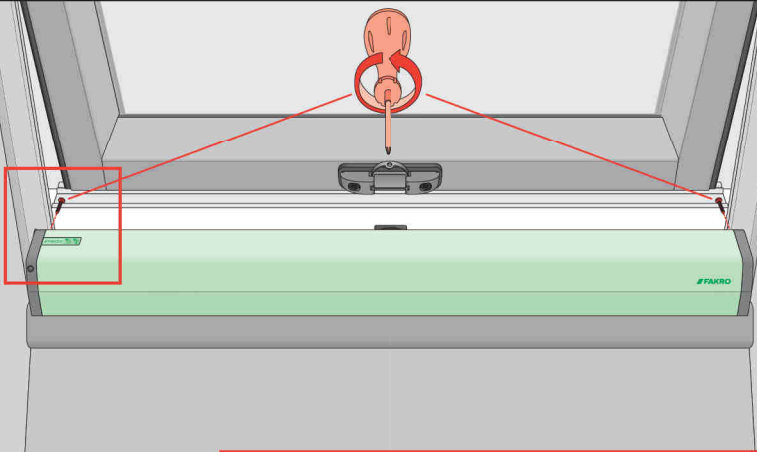

8a

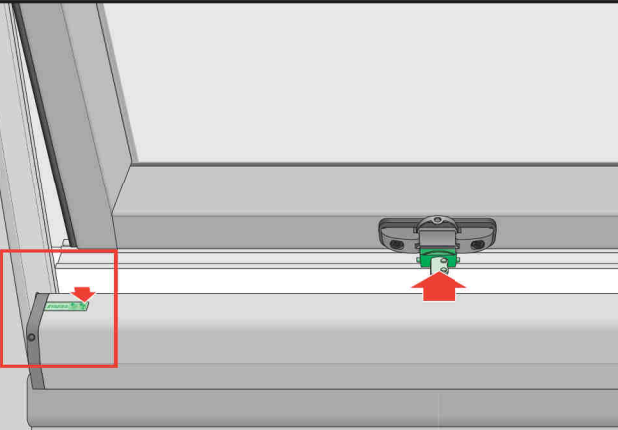

8b

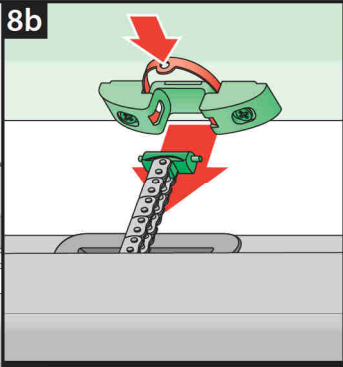

8c

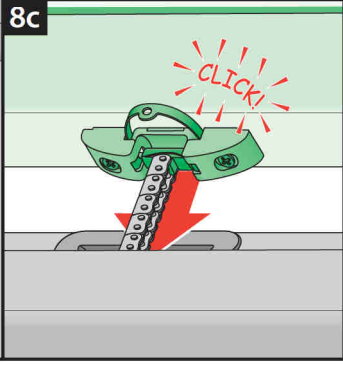

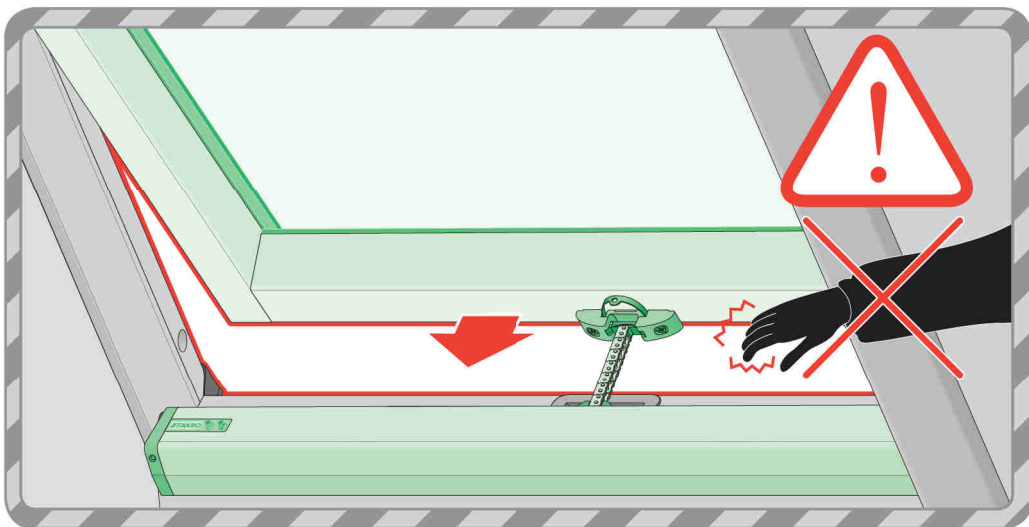
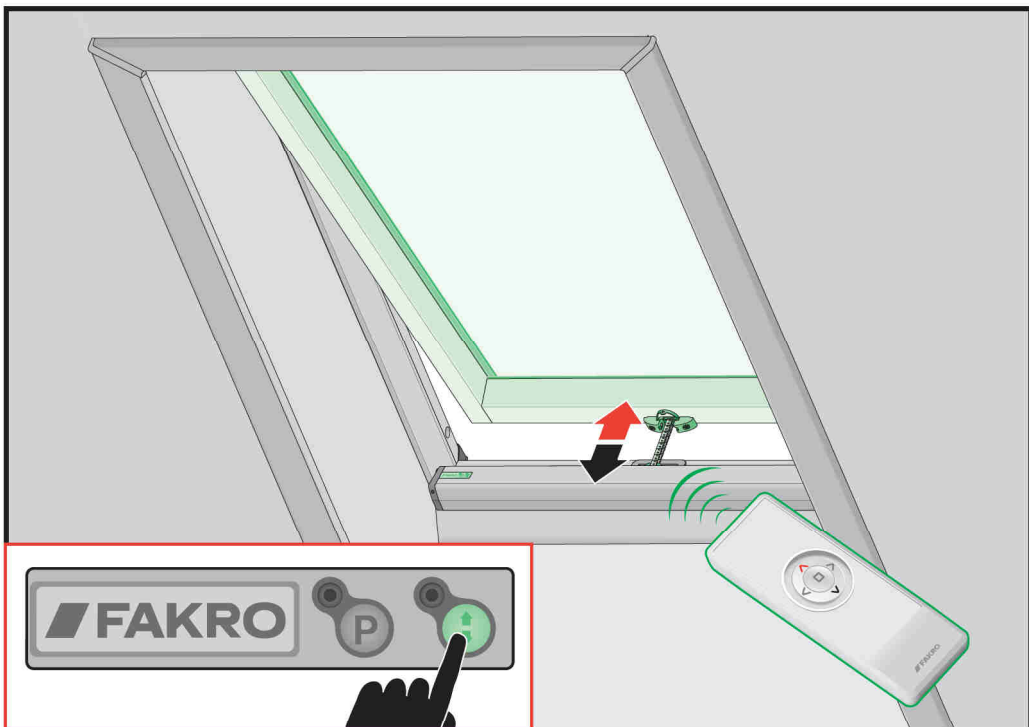

CZ Vyrobc a predávce nenesú žiadnu zodpovednosť za nedodržanie príslušných ustanovení zákona, stavebných predpisů a bezpečnostných požiadavkú užívateľom výrobku, architektom, montážnym alebo majiteľom objektu.

ES El fabricante y el vendedor no tienen ninguna responsabilidad por el incumplimiento de la ley vigente, normas de construcción y exigencias de seguridad por parte del usuario del producto, arquitecto, instalador o el propietario del edificio.

GB Manufacturer and Seller shall bear no liability for failure to comply with the applicable laws, building codes and safety requirements by the user of the product, architect, fitter or owner of the building.

IT Il Produttore e il Rivenditore non potranno essere ritenuti responsabili per il mancato rispetto, da parte dell'utente del prodotto, del progettista, dell'installatore o del proprietario dell'edificio, delle leggi vigenti, nonché dei regolamenti edilizi e di quelli relativi alla sicurezza.

PL Producent i Sprzedawca nie ponoszą żadnej odpowiedzialności za nieprzestrzeganie stosownych przepisów prawa, przepisów budowlanych i wymogów bezpieczeństwa przez użytkownika produktu, architekta, montażystę lub właściciela budynku.

RO Nici producătorul, nici distribuitorul nu își vor asuma niciun fel de răspundere pentru nerespectarea legilor în vigoare, a legilor din domeniul construcțiilor sau a măsurilor de siguranță impuse utilizatorilor produsului, arhitecților, montajerilor sau proprietarilor clădirii.

SK Vyrobc a predaja nenesú žiadnu zodpovednosť za nedodržanie príslušných ustanovení zákona, stavebných predpisů a bezpečnostných požiadavkú užívateľom výrobku, architektom, montážnym alebo majiteľom objektu.

DE Hersteller und Verkäufer übernehmen keine Haftung für Nichtbeachtung entsprechender Rechts- und Bauvorschriften sowie Sicherheitsanforderungen seitens Produktbenutzers, Architekten, Monteurs oder Gebäudebesitzers.

FR Le fabricant et le revendeur ne prend aucune responsabilité de ne pas respecter les lois applicables, les règlements sur les bâtiments et les exigences de sécurité par l'utilisateur du produit, l'architecte, l'installateur ou le propriétaire du bâtiment.

HU A Gyártó és a Forgalmazó nem vállal semmiféle felelősséget a vonatkozó törvény, építési és biztonsági előírások, terméklehazsnál, építész, beépítőmester vagy épülettulajonos által be nem tartásért.

NL De fabrikant en verkoper zijn niet aansprakelijk voor gevolgen bij het niet opvolgen van toepasselijke wetten, bouwbesluiten en veiligheidsvoorschriften door de gebruiker van het product, de architect, de installateur of de eigenaar van het gebouw.

PT O fabricante e o vendedor não tem nenhuma responsabilidade pelo o não cumprimento da lei, códigos de construção e as exigências de segurança por parte do usuário do produto, arquiteto, instalador ou proprietário do edifício.

RU В случае необходимости архитектором, монтажником или владельцем здания строительных правил и норм безопасности ответственность с производителя и продавца снимается.

